

## Check Valves

### *Index*

100 Series	1
200/H200 Series	3
2200 Series	9
2300 Series	11
C200 Series	15
C2900 Series	17
400/H400 Series	19
BIVCO Check Valves	23



*check valves*

# 100 Series

0 to 25 psig Check Valves



## Features & Benefits

### Low pressure

- Lightweight check valve for pressures to 25 psig.

### Ultra-sensitive

- Unique design allows flow with minimum pressure differential. Cracking pressure is 4" H<sub>2</sub>O maximum.

### Positive sealing

- Unique knife-edge on the poppet positions snugly to provide zero sealing even with extremely low pressure.

### Zero leakage

- Compact, easy installation. Efficient, inline design reduces size and weight. The valve can be mounted in any position.

## Technical Data

<b>Body Construction Materials</b>	Aluminum, brass, steel, 303 or 316 stainless steel
<b>O-ring Materials</b>	Buna N or Viton®
<b>Operating Pressure</b>	25 psig (1.7 bar)
<b>Cracking Pressure</b>	4" H <sub>2</sub> O maximum
<b>Temperature Range</b>	-40° F to +400° F (-40° C to +204° C) <i>Based on o-ring &amp; body material, see "How to Order"</i>
<b>Connection Sizes</b>	1/8" to 3/4"

*Note: Proper filtration is recommended to prevent damage to sealing surfaces.*

## How it Works

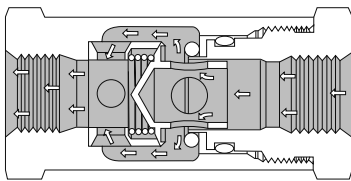

### Open

Full flow passages offer minimum restriction to flow. Spring is completely removed from flow path

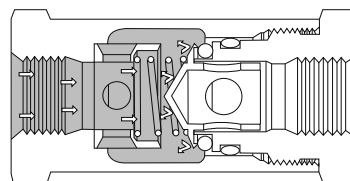

### Closed

As the inlet supply pressure decreases, a light spring closes the poppet, positioning the knife-edge automatically in line of contact sealing against the o-ring. The impression of the knife edge is limited by a metal-to-metal seat, which carries the reverse pressure load and serves to prevent sticking of the o-ring.

check valves

## Circle Seal Controls

2301 Wardlow Circle • Corona, CA 92880  
 Phone (951) 270-6200 • Fax (951) 270-6201  
 www.circlesealcontrols.com

# 100 Series

## Dimensions

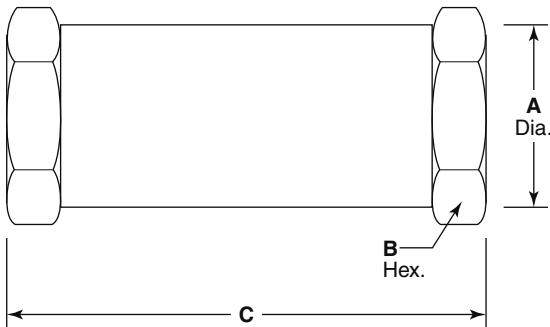

Pipe, Female	Size	A Dia.	B Hex	C
-1PP	1/8"	0.81	0.81	1.70
-2PP	1/4"	1.00	1.00	2.25
-3PP	3/8"	1.12	1.12	2.43
-4PP	1/2"	1.50	1.50	2.93
-6PP	3/4"	1.75	1.75	3.37

## Flow Curve

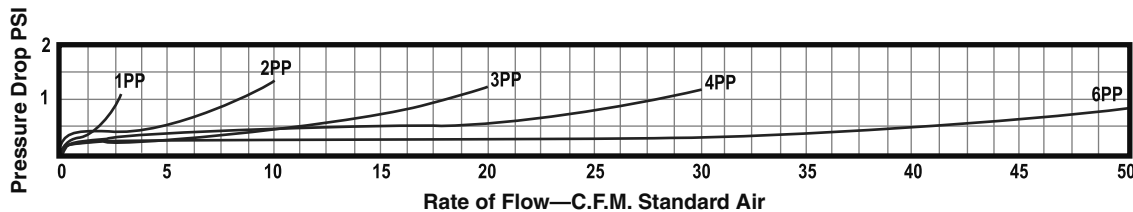

## How to Order

**1 19 B - 2 PP**

**O-RING MATERIAL & TEMPERATURE RANGE**

- 19** Buna N, -40° F to +250° F
- 32** Viton®, -20° F to +400° F

**MATERIAL**

- A** Aluminum
- B** Brass
- T** 303 stainless steel†
- T1** 316 stainless steel

**CONNECTIONS—INLET/OUTLET**

- P** Female pipe, NPT

**VALVE SIZE**

- 1** 1/8"
- 2** 1/4"
- 3** 3/8"
- 4** 1/2"
- 6** 3/4"

† Not available for PED applications.

Please consult Circle Seal Controls or your local distributor for information on special connections, o-rings, operating pressures, reseal pressures and temperature ranges.

### Repair Kits

In normal service, the only part(s) which may require replacement is(are) the seal(s). A repair kit may be ordered by placing a 'K/' in front of the complete part number (i.e. K/119B-2PP).

Although we offer separate kits where o-ring replacement is considered necessary, factory repair is recommended. Because of the ultra-sensitive characteristics of this valve, extreme care is necessary to insure that the o-ring is properly fitted into the groove without being twisted or distorted.

### For Your Safety

It is solely the responsibility of the system designer and user to select products suitable for their specific application requirements and to ensure proper installation, operation, and maintenance of these products. Material compatibility, product ratings and application details should be considered in the selection. Improper selection or use of products described herein can cause personal injury or property damage.

Viton® is a registered trademark of DuPont Dow Elastomers.

## 200 Series 0 to 3000 psig Check Valves

## H200 Series 0 to 6000 psig Check Valves



### Features & Benefits

#### Quick opening/positive closing

- Provides a wide range of adaptability

#### Large flow capacity

- The patented sealing principle effects complete leakproof closing under all pressure conditions

#### Zero leakage

- Compact, easy installation. Efficient inline piston reduces size and weight

#### Floating o-ring

- The streamlined poppet and full ports offer minimum restriction to flow

### Technical Data

<b>Body Construction Materials</b>	Aluminum, brass, steel, 303 or 316 stainless steel
<b>O-ring Materials</b>	Buna N, ethylene propylene, fluorosilicone, Kalrez®, neoprene, PTFE, and Viton®
<b>Operating Pressure</b>	200 Series: to 3000 psig (207 bar) H200 Series: to 6000 psig (414 bar)
<b>Proof Pressure</b>	1.5 times operating pressure
<b>Rated Burst Pressure</b>	200 Series: 2.5 : 1 H200 Series: 4 : 1
<b>Cracking Pressure</b>	0.1 to 25 psig (0.007 to 1.72 bar)
<b>Temperature Range</b>	-320° F to +550° F (-196° C to +288° C) Based on o-ring & body material, see "How to Order"
<b>Connection Sizes</b>	1/8" to 2"

Note: Proper filtration is recommended to prevent damage to sealing surfaces.

### How it Works

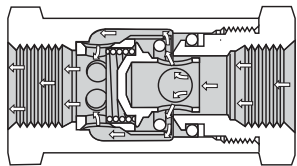

#### Open

Full flow passages offer minimum restriction to flow. Spring is completely removed from flow path

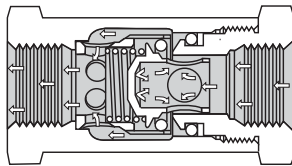

#### Closing

Floating o-ring automatically establishes line contact with conical metal surfaces of poppet and seat to cushion closing and insure perfect sealing.

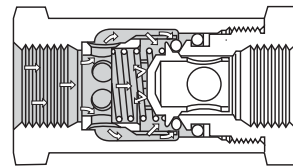

#### Closed

O-ring only seals. Full pressure load is carried by metal-to-metal seat. Increasing pressure increases sealing efficiency; metal seat prevents any possibility of deformation or extrusion of o-ring.

check valves

### Circle Seal Controls

2301 Wardlow Circle • Corona, CA 92880  
Phone (951) 270-6200 • Fax (951) 270-6201  
www.circlesealcontrols.com

# 200 Series / H200 Series

## Cracking Pressure

Minimum cracking pressure available: 0.1 psig

Standard cracking pressure: see page 7

Maximum cracking pressure available: 25 psig

Note: Cracking pressure is defined at which flow is 5cc/min except for 220 Series for which flow is approximately 0.02 cfm. When ordering a cracking pressure within the standard range or below the standard range of the cracking pressure, the dash number is a "maximum". Example: 259A-4TT-.3 (cracking pressure tolerance will be +0%, -50%). When ordering a cracking pressure equal to or greater than the upper limit of the standard cracking pressure shown above, cracking pressure tolerance will be ±10%. Example: 259A-4TT-5. Cracking pressure over 8 psig should not be specified without consulting the factory. Where 200 Series valves are supplied with higher cracking pressures, a shroud ring may be used to confine the o-ring.

Note: Reseat pressure is the back pressure required to seal a check valve. It varies with different springs and seals. Reseat pressure is not specified unless called out on the sales order.

## Leakage

External: Zero

Internal:

Elastomeric seals: Zero

PTFE seals: 0-50 psig = 5cc/min max.

50+ psig = 0.5cc/min max.

## Operating Pressure: 200 Series

Aluminum (A)	Tube	3/16"-1 1/2"	0-3000 psig to 200° F
	Pipe	1/8"-1 1/2"	0-3000 psig to 200° F
Brass	Tube	3/16"-1 1/2"	0-3000 psig to 300° F
	Pipe	1/8"-1 1/2"	0-3000 psig to 300° F
	Pipe	2"	0-1500 psig to 300° F
Steel	Tube	3/16"-1 1/2"	0-3000 psig to 300° F
	Pipe	1/8"-2"	0-3000 psig to 300° F
Stainless steel	Tube	3/16"-1 1/2"	0-3000 psig to 450° F
	Pipe	1/8"-2"	0-3000 psig to 450° F

## Operating Pressure: H200 Series

Aluminum (A)	Tube	3/16"-1 1/4"	0-6000 psig to 200° F
	Pipe	1/8"-1 1/2"	0-6000 psig to 200° F
Brass	Tube	3/16"-1 1/4"	0-5000 psig to 300° F
	Pipe	1/8"-1 1/2"	0-5000 psig to 300° F
Steel	Tube	3/16"-1 1/4"	0-5000 psig to 300° F
	Pipe	1/8"-2"	0-5000 psig to 300° F
Stainless steel	Tube	3/16"-2"	0-6000 psig to 450° F
	Pipe	1/8"-2"	0-6000 psig to 450° F

## End Connections, Dimensions (Inches) & Weights

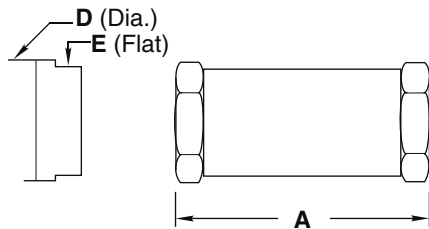

Optional  
(Based on availability)

### -RR, -BB: Female Tube

Dash No.	Tube Size	A ±0.050	C Hex & Rd.	Opt. Dimensions		Weights (Lbs)	
				D	E	Alum.	All Steel
-4BB	1/4"	1.98	0.75	—	—	0.06	0.16
-5BB	3/16"	2.07*	0.81	—	—	0.08	0.22
-6BB	3/8"	2.44	0.81	—	—	0.08	0.22
-8BB	1/2"	3.06	1.00	—	—	0.13	0.37
-10BB	5/8"	3.42	1.12	—	—	0.18	0.50
-12BB	3/4"	3.83	1.50	1.75	1.50	0.34	0.88
-16BB	1"	4.37	1.75	2.00	1.75	0.52	1.50
-20BB	1 1/4"	4.99	2.00	2.25	2.00	0.68	2.18
-24BB	1 1/2"	5.75	2.75	2.75	2.25	2.05	5.95

\* Exception: 200T-5BB, 'A' dimension is 2.44

### -BT: Female Tube to Male Tube

### -TB: Male Tube to Female Tube

Dash No.	Tube Size	A ±0.050	B Ref.	C Hex & Rd.	Opt. Dimensions		Weights (Lbs)	
					D	E	Alum.	All Steel
-4BT	1/4"	1.53	2.08	0.75	—	—	0.06	0.15
-6BT	3/16"	1.98	2.54	0.81	—	—	0.08	0.21
-8BT	1/2"	2.37	3.03	1.00	—	—	0.12	0.34
-12BT	3/4"	3.00	3.86	1.50	1.75	1.50	0.32	0.96
-16BT	1"	3.50	4.41	1.75	2.00	1.75	0.50	1.46
-20BT	1 1/4"	3.97	4.93	2.00	2.25	2.00	0.68	1.90
-24BT	1 1/2"	4.73	5.81	2.75	2.75	2.25	1.82	5.31

Dash No.	Tube Size	A ±0.050	B Ref.	C Hex & Rd.	Opt. Dimensions		Weights (Lbs)	
					D	E	Alum.	All Steel
-4TB	1/4"	1.98	2.53	0.75	—	—	0.07	0.20
-5TB	3/16"	1.98	2.53	0.81	—	—	0.07	0.20
-6TB	3/8"	1.98	2.54	0.81	—	—	0.08	0.21
-8TB	1/2"	2.49	3.15	1.00	—	—	0.14	0.37
-10TB	5/8"	2.80	3.56	1.12	—	—	0.18	0.50
-12TB	3/4"	3.33	4.19	1.50	1.75	1.50	0.37	1.07
-16TB	1"	3.74	4.65	1.75	2.00	1.75	0.55	1.60
-20TB	1 1/4"	4.39	5.35	2.00	2.25	2.00	0.80	2.30
-24TB	1 1/2"	5.06	6.14	2.75	2.75	2.25	2.03	5.90

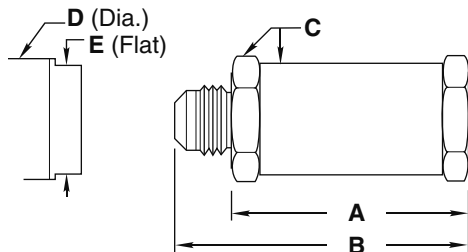

Optional  
(Based on availability)

# 200 Series / H200 Series

## H200 Series

End Connection	Alum.	Brass	St. Steel	Steel		
	(Stock Size Hex)			D Dia.	E	F ± 0.015
-3T / -3C	0.625	0.625	0.625	0.650	0.560	0.220
-4T / -4B	0.875	0.875	0.812	0.875	0.750	0.280
-1P/-5T, -6T, -6B	0.937	0.937	0.875	0.960	0.813	0.280
-2P/-8T, -8B	1.125	1.250	1.125	1.250	1.000	0.300
-3P/-10T, -10B	1.375	1.375	1.250	1.375	1.125	0.350
-4P/-12T, -12B	1.750	1.875	1.750	1.875	1.625	0.450
-6P/-16T, -16B	2.000	2.250	2.000	2.125	1.875	0.500
-8P/-20T, -20B	2.250	2.500	2.250	2.50	2.125	0.620

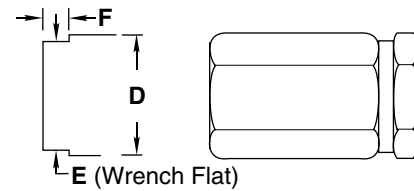

Optional  
(Based on availability)

## -PP: Female Pipe

Dash No.	Tube Size	A ±0.050	B Ref.	C Hex & Rd.	Opt. Dimensions		Weights (Lbs)	
					D	E	Alum.	All Steel
-1PP	1/8"	1.70	0.81	—	—	0.05	0.15	0.14
-2PP	1/4"	2.25	1.00	—	—	0.12	0.36	0.34
-3PP	3/8"	2.43	1.12	—	—	0.15	0.46	0.43
-4PP	1/2"	2.93	1.50	1.50	1.25	0.32	0.98	0.92
-6PP	3/4"	3.37	1.75	1.75	1.50	0.49	1.50	1.41
-8PP	1"	3.99	2.00	2.00	1.75	0.73	2.25	2.11
-10PP	1 1/4"	4.50	2.75	2.75	2.25	1.60	5.00	4.80
-12PP	1 1/2"	5.35	2.75	2.75	2.25	1.73	5.34	4.97
-16PP	2"	6.10	—	3.50	2.75	2.60	8.00	7.50

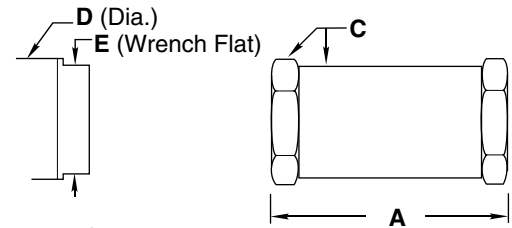

Optional  
(Based on availability)

## -TT: Female Tube

Dash No.	Tube Size	A ±0.050	B Ref.	C Hex & Rd.	Opt. Dimensions		Weights (Lbs)	
					D	E	Alum.	All Steel
-3TT	3/16"	0.97*	1.93*	0.56*	—	—	0.03	0.08
-4TT	1/4"	1.53	2.63	0.75	—	—	0.07	0.18
-5TT	5/16"	1.53	2.63	0.81	—	—	0.07	0.20
-6TT	3/8"	1.53	2.63	0.81	—	—	0.07	0.20
-8TT	1/2"	1.81	3.12	1.00	—	—	0.13	0.35
-10TT	5/8"	2.06	3.58	1.12	—	—	0.18	0.49
-12TT	3/4"	2.50	4.23	1.50	1.75	1.50	0.35	1.00
-16TT	1"	2.87	4.69	1.75	2.00	1.75	0.53	1.50
-20TT	1 1/4"	3.37	5.29	2.00	2.25	2.00	0.79	2.30
-24TT	1 1/2"	4.04	6.21	2.75	2.75	2.25	1.80	5.22

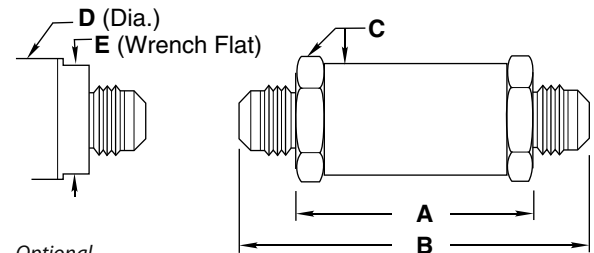

Optional  
(Based on availability)

Exception: 200T-3TT: 'A' dimension is 1.00, 'B' dimension is 1.96, 'C' dimension is 0.625

# 200 Series / H200 Series

## Flow Curves

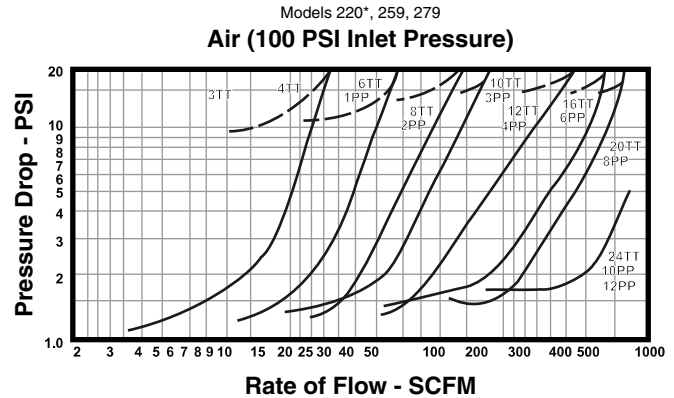
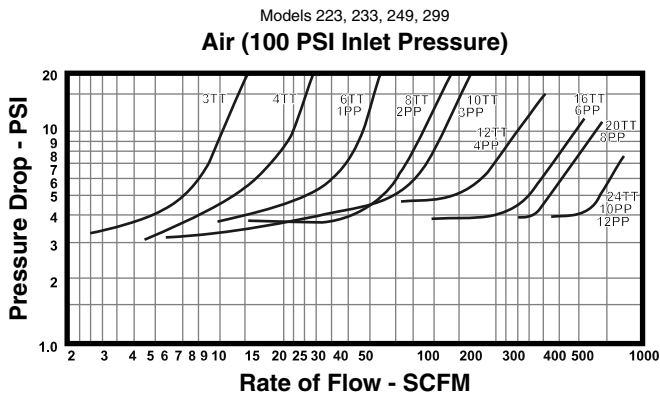
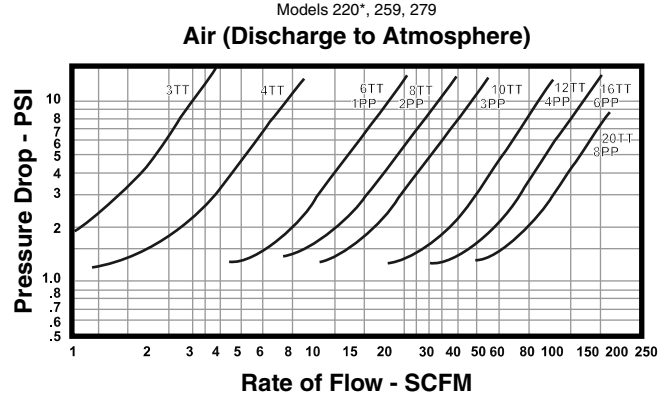
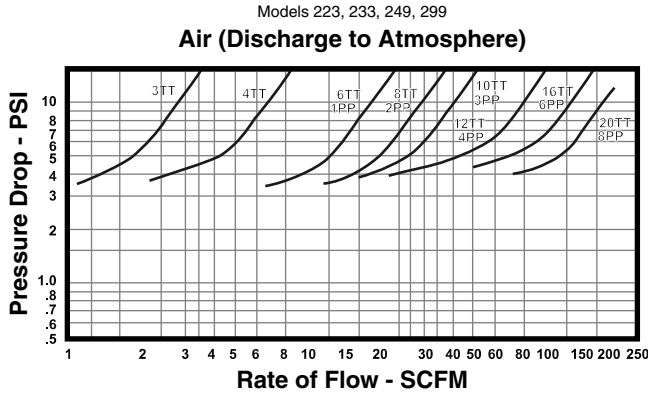
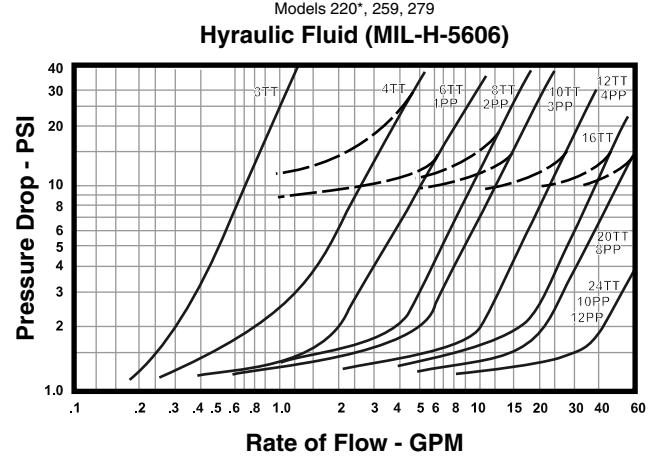
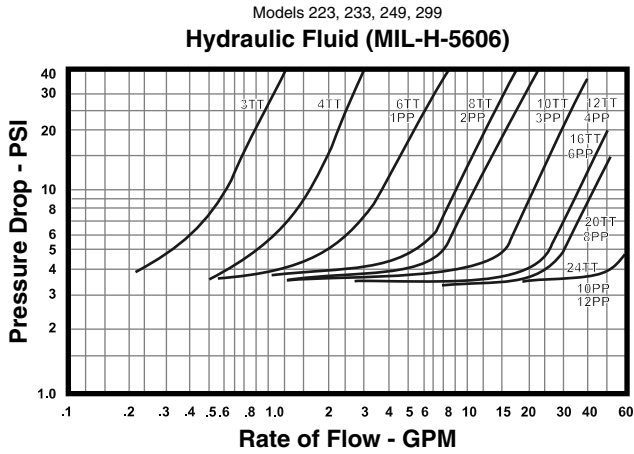

### Flow Rates

Valve size	Tube	3	4	6	8	10	12	16	20	24	32
	Pipe	—	—	1	2	3	4	6	8	10-12	16
Cv (nominal)		0.30	0.7	1.6	2.7	3.5	6.6	10.3	12.5	23.2	51

# 200 Series / H200 Series

## How to Order

**H 2 49 T1 - 4TT (L) - 1**

### VARIATION

- H** Modified construction for 6000 psig service (1/4" to 1 1/2" tube, 1/8" to 1 1/4" pipe and larger)
- K** Cryogenic service, special cleaning and testing (stainless steel valves only)

### O-RING MATERIAL, TEMPERATURE & CRACKING PRESSURE RANGE

- 49** Buna N, -65° F to +250° F, 2-4 psig
- 59** Buna N, -65° F to +275° F, 0.5-1 psig
- 69** Buna N (fuels), -65° F to +180° F, 0.5-1 psig
- 62** Ethylene propylene, -65° F to +300° F, 2-4 psig
- 64** Fluorosilicone, -80° F to +350° F, 0.5-1 psig
- 65** Kalrez®, -40° F to +550° F, 0.5-1 psig
- 33** Neoprene, -40° F to +300° F, 2-4 psig
- 53** Neoprene, -40° F to +250° F, 0.5-1 psig
- 24** Silicone, -70° F to +450° F, 0.5-1 psig
- 32** Viton®, -20° F to +400° F, 0.5-1 psig
- 20\*** PTFE, -100° F to +400° F, 8 psig maximum
- 20\*** PTFE (K220T), -320° F to +165° F, 8 psig maximum
- 80\*** PTFE (no cryogenic testing), -320° F to +165° F, 8 psig

### MATERIAL

- A** 2024-T4/T351 aluminum<sup>††</sup>
- B** Brass<sup>††</sup>
- A1** 6061-T6/T651 aluminum<sup>††</sup>
- S** Steel<sup>†</sup>
- T** 303 stainless steel<sup>†</sup>
- T1** 316 stainless steel

### CRACKING PRESSURE

Call out dash number if not standard  
**1** 1 psig

### SPECIAL CHARACTERISTICS

- 030** Hole in poppet head, thousandth of an inch
- L** Lock wire

### SIZE & END CONNECTIONS (INLET/OUTLET)

- Pipe sizes in 1/8" increments
- Tube sizes in 1/16" increments
- P** Female pipe, NPT
- T** Male tube, AS4395 (MS33656)
- B** Female tube, AND10050
- C** Gyrolok® tube fittings
- D** Male straight thread, AS4395 (MS33656) w/ cone point removed
- E** Flareless male tube, MS33514 (SAE)
- F** Male tube, SAE flare 45°
- H** Hose, MS33658
- J** Female tube, MS33649
- K** British parallel pipe (male)
- L** British parallel pipe (female)
- R** Female tube, SAE straight thread, MS16142
- S** British taper pipe (male)
- X** British taper pipe (female)
- U** Bulkhead tube, AS4396 (MS33657)

\* For PTFE, specify stainless steel body material. The stainless steel valve design provides a PTFE static seal for use in systems with low or high temperatures or with liquids or gases which would cause excessive swell or shrinkage of elastomeric compounds.

† Not available for PED applications.

†† For PED applications, brass bodies are limited to a maximum temperature of +100° F (+38° C), aluminum bodies are limited to a maximum temperature of +200° F (+93° C)

## Repair Kits

In normal service, the only part(s) which may require replacement is(are) the seal(s). A repair kit may be ordered by placing a 'K/' in front of the complete part number (i.e. K/H249T1-4TT(L)-1).

## For Your Safety

It is solely the responsibility of the system designer and user to select products suitable for their specific application requirements and to ensure proper installation, operation, and maintenance of these products. Material compatibility, product ratings and application details should be considered in the selection. Improper selection or use of products described herein can cause personal injury or property damage.

Gyrolok® is a registered trademark of HOKE Incorporated.  
 Kalrez® and Viton® are registered trademarks of DuPont Dow Elastomers.





## 2200 Series

0 to 800 psig Check Valves



### Features

- Medium flow
- Single piece design
- Resilient o-ring

### Benefits

- Maintenance free
- Dependable
- Economical

### Technical Data

<b>Body Construction Materials</b>	Brass, 316 stainless steel
<b>O-ring Materials</b>	Buna N, ethylene propylene, neoprene, silicone, or Viton®
<b>Operating Pressure</b>	0 to 800 psig (55 bar)
<b>Proof Pressure</b>	1,200 psig (83 bar)
<b>Cracking Pressure</b>	1 to 3 psig (0.07 to 0.21 bar)
<b>Temperature Range</b>	-70° F to +450° F (-57° C to +232° C) <i>Based on o-ring &amp; body material, see "How to Order"</i>
<b>Connection Sizes</b>	1/8" to 1"

*Note: Proper filtration is recommended to prevent damage to sealing surfaces.*

### How it Works

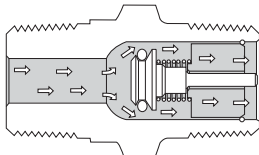

#### Open

Flow passes smoothly over poppet head with minimum turbulence and through the fluted guide without restriction.

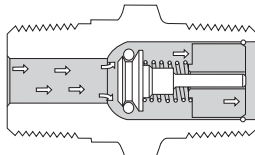

#### Closing

O-ring automatically establishes line of contact with spherical seat to cushion closing and insure perfect sealing.

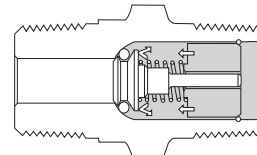

#### Closed

O-ring only seals. Full pressure is carried by metal-to-metal seat.

check valves

### Circle Seal Controls

2301 Wardlow Circle • Corona, CA 92880  
 Phone (951) 270-6200 • Fax (951) 270-6201  
 www.circlesealcontrols.com

# 2200 Series

## Dimensions, Pressure Drop & Flow Rates

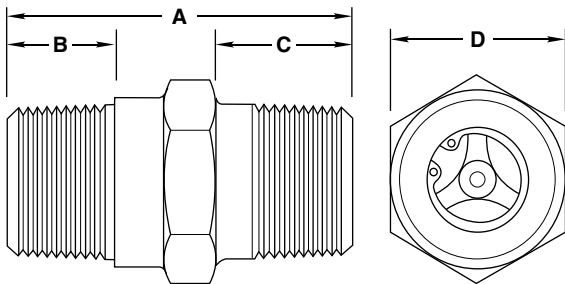

2200 Series Dimensions (inches), Male Pipe

Model Number	Size	A		B & C		D	
		-MM	-SS	-MM	-SS	-MM	-SS
-1MM / -1SS	1/8"	1.30	1.32	0.39	0.40	0.50	0.50
-2MM / -2SS	1/4"	1.59	1.70	0.54	0.60	0.63	0.63
-3MM / -3SS	3/8"	1.59	1.73	0.54	0.61	0.75	0.75
-4MM / -4SS	1/2"	2.13	2.20	0.78	0.81	0.88	0.88
-6MM / -6SS	3/4"	2.15	2.33	0.78	0.86	1.13	1.13
-8MM / -8SS	1"	2.57	2.68	0.97	1.02	1.38	1.38

### Maximum Allowable Pressure Drop

Model Number	Size	2249 & 2262 Series		2224, 2232, 2233 & 2259 Series	
		Air	Oil	Air	Oil
-1MM / -1SS	1/8"	10 psid	15 psid	5 psid	10 psid
-2MM / -2SS	1/4"	10 psid	15 psid	5 psid	10 psid
-3MM / -3SS	3/8"	10 psid	15 psid	5 psid	10 psid
-4MM / -4SS	1/2"	10 psid	15 psid	5 psid	10 psid
-6MM / -6SS	3/4"	10 psid	15 psid	5 psid	10 psid
-8MM / -8SS	1"	10 psid	15 psid	5 psid	10 psid

### Flow Rates

Valve size	-1MM	-2MM	-3MM	-4MM	-6MM	-8MM
Cv (nominal)	0.26	0.74	1.1	2.1	4.7	6.6

## How to Order

**22 59 B - 2 MM - 1**

### O-RING MATERIAL, TEMPERATURE & STANDARD CRACKING RANGE

- 49** Buna N, -65° F to +250° F, 4.0 psig
- 59** Buna N, -65° F to +275° F, 2.0 psig
- 62** EPDM, -65° F to +300° F, 4.0 psig
- 33** Neoprene, -40° F to +300° F, 4.0 psig
- 24** Silicone, -70° F to +450° F, 2.0 psig
- 32** Viton®, -20° F to +400° F, 2.0 psig
- 20** PTFE, -100° F to +400° F, 4.0 psig

### BODY MATERIAL

- B** Brass<sup>†</sup>
- T1** 316 stainless steel

### CRACKING PRESSURE

Call out dash number if not standard  
**1** 1 psig

### CONNECTIONS—INLET/OUTLET

**M** Male pipe, NPT  
**S** Male British taper pipe

### VALVE SIZE

- 1** 1/8"
- 2** 1/4"
- 3** 3/8"
- 4** 1/2"
- 6** 3/4"
- 8** 1"

<sup>†</sup> For PED applications, brass bodies are limited to a maximum temperature of +100° F (+38° C).

Please consult Circle Seal Controls or your local distributor for information on special connections, o-rings, operating pressures, reseal pressures and temperature ranges.

### Leakage

2249, 2262 Series	zero @ 3 psig to 800 psig
2259, 2232, 2233 & 2224 Series	zero @ 1 psig to 800 psig
2220 Series	10cc/min maximum from zero to 75 psig; zero from 75 psig to 800 psig

### Cracking Pressure

Minimum cracking pressure available: 0.1 psig

Maximum cracking pressure available: 7.0 psig

Note: Cracking pressure is defined as pressure at which flow is 5cc/min, except the 2220 Series, for which flow is approximately 0.02 cfm. For standard cracking pressures and less (example: 2259-2MM-3), the tolerance is +0%, -100%. For cracking pressure greater than standard (example: 2259B-2MM-5), the tolerance is ±20%.

## For Your Safety

It is solely the responsibility of the system designer and user to select products suitable for their specific application requirements and to ensure proper installation, operation, and maintenance of these products. Material compatibility, product ratings and application details should be considered in the selection. Improper selection or use of products described herein can cause personal injury or property damage.

Viton® is a registered trademark of DuPont Dow Elastomers.

# 2300 Series

0 to 10000 psig Check Valve



## Features

- Designed for high pressure service
- Resilient o-ring
- Single piece design

## Benefits

- Less susceptible to contamination damage
- Zero leakage at normal back pressure
- Automatic compensation for wear
- Cushioned, quiet closing

## Technical Data

<b>Body Construction Materials</b>	Aluminum, brass, 303 stainless steel, or 17-4 PH stainless steel
<b>O-ring Materials</b>	Buna N, ethylene propylene, neoprene, PTFE and Viton®
<b>Operating Pressure</b>	<ul style="list-style-type: none"> <li>• Aluminum: 0 to 5000 psig (345 bar) (for temperatures under 250° F)</li> <li>• Brass: 0 to 5000 psig (345 bar)</li> <li>• 303 stainless steel: 0 to 7500 psig (517 bar)</li> <li>• 17-4 PH stainless steel: 0 to 10000 psig (690 bar)</li> </ul>
<b>Proof Pressure</b>	<ul style="list-style-type: none"> <li>• Aluminum: 7500 psig (517 bar)</li> <li>• Brass: 7500 psig (517 bar)</li> <li>• 303 stainless steel: 11,250 psig (776 bar)</li> <li>• 17-4 PH stainless steel: 15000 psig (1,034 bar)</li> </ul>
<b>Rated Burst Pressure</b>	<ul style="list-style-type: none"> <li>• Aluminum: 12500 psig (862 bar)</li> <li>• Brass: 12500 psig (862 bar)</li> <li>• 303 stainless steel: 18,750 psig (1,293 bar)</li> <li>• 17-4 PH stainless steel: 25000 psig (1,724 bar)</li> </ul>
<b>Temperature Range</b>	-100° F to +400° F (-73° C to +204° C) Based on o-ring & body material, see "How to Order"
<b>Connection Sizes</b>	1/8" to 1"

Note: Proper filtration is recommended to prevent damage to sealing surfaces.

## How it Works

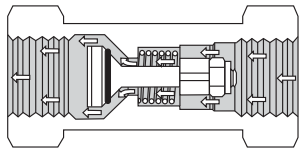

### Open

Flow passes smoothly over poppet head with minimum turbulence.

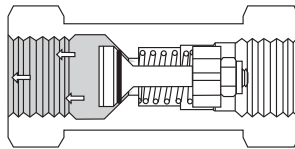

### Closing

O-ring automatically establishes line of contact with conical seat to cushion closing and insure perfect sealing.

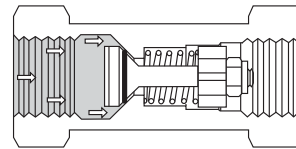

### Closed

O-ring only seals. Full pressure is carried by metal-to-metal seat. Increasing pressure increases sealing efficiency.

## Circle Seal Controls

2301 Wardlow Circle • Corona, CA 92880  
Phone (951) 270-6200 • Fax (951) 270-6201  
www.circlesealcontrols.com

check valves

# 2300 Series

## End Connection & Dimensions (Inches)

### -PP: Female / Female Pipe

Dash No.	Pipe Size	B Hex	C	F	G
-1PP	1/8"	0.625	1.50	0.59	0.31
-2PP	1/4"	0.813	2.00	0.77	0.41
-3PP	3/8"	1.000	2.35	0.95	0.50
-4PP	1/2"	1.250	2.89	1.19	0.56
-6PP	3/4"	1.500	3.30	1.43	0.69

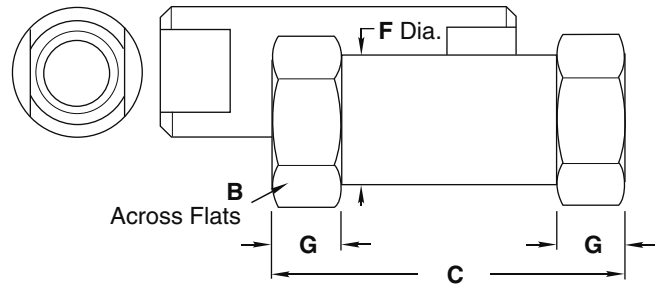

### -MM: Male / Male Pipe

Dash No.	Pipe Size	B Hex	C	E	F Dia.	G
-2MM	1/4"	0.625	1.82	0.60	0.59	0.31
-3MM	3/8"	0.813	2.21	0.61	0.77	0.41
-4MM	1/2"	1.000	2.75	0.79	0.95	0.50
-6MM	3/4"	1.250	3.03	0.80	1.19	0.56
-8MM	1"	1.500	3.67	0.99	1.43	0.69

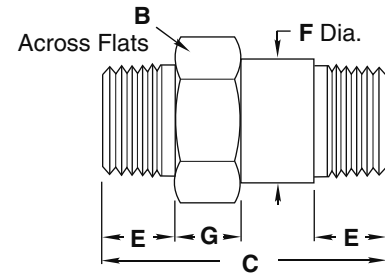

### -MP: Male / Female Pipe

Dash No.	Pipe Size	B Hex	C	E	F Dia.	G
-1MP	1/8"	0.625	1.46	0.40	0.59	0.31
-2MP	1/4"	0.813	1.67	0.60	0.77	0.41
-3MP	3/8"	1.000	2.07	0.61	0.95	0.50
-4MP	1/2"	1.250	2.56	0.79	1.19	0.56
-6MP	3/4"	1.500	2.88	0.80	1.43	0.69

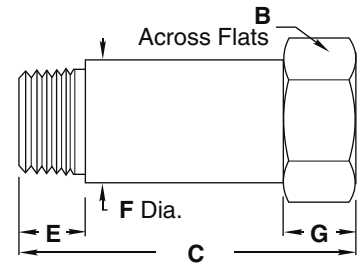

# 2300 Series

## End Connection & Dimensions (Inches)

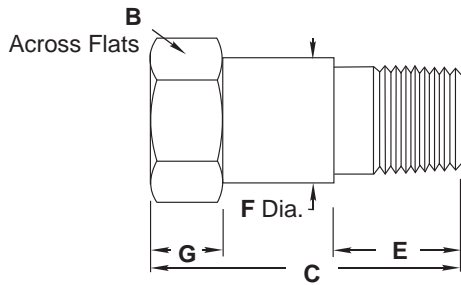

### -PM: Female / Male Pipe

Dash No.	Pipe Size	B Hex	C	E	F Dia.	G
-2PM	1/4"	0.813	1.93	0.60	0.77	0.41
-3PM	3/8"	1.000	2.26	0.61	0.95	0.50
-4PM	1/2"	1.250	2.89	0.79	1.19	0.56

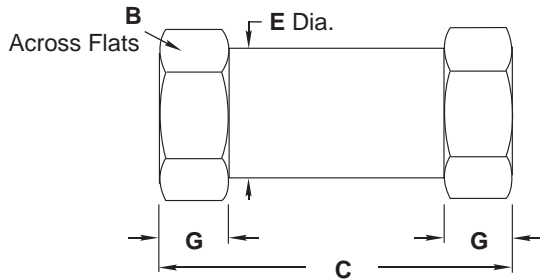

### -BB: Female / Female Tube

Dash No.	Tube Size	B Hex	C	E Dia.	G
-4BB	1/4"	0.688	2.00	0.66	0.24
-6BB	3/8"	0.813	2.40	0.77	0.41
-8BB	1/2"	1.250	3.34	1.19	0.56
-10BB	5/8"	1.250	3.53	1.19	0.56
-12BB	3/4"	1.500	4.15	1.43	0.69

# 2300 Series

## How to Order

**23 49 R - 2 PP - 7**

### O-RING MATERIAL, TEMPERATURE & STANDARD CRACKING RANGE

- 62** EPDM, -65° F to +300° F, 0.5-1.5 psig
- 49** Buna N, -65° F to +250° F, 2-5 psig
- 59** Buna N, -65° F to +275° F, 0.5-1.5 psig
- 33** Neoprene, -40° F to +240° F, 2-5 psig
- 20** PTFE, -100° F to +400° F, 5 psig
- 32** Viton®, -20° F to +400° F, 0.5-1.5 psig

### BODY MATERIAL

- A** 2024-T4/T351 aluminum†
- B** Brass†
- R** 17-4 PH stainless steel
- T** 303 stainless steel

### CRACKING PRESSURE

Call out dash number if not standard\*

**7** 7 psig

### CONNECTIONS

- P** Female pipe, NPT
- M** Male pipe, NPT
- B** Female tube, AND10050
- S** British taper, male pipe
- X** British taper, female pipe

### CONNECTION SIZE

Pipe sizes in 1/8" increments  
Tube sizes in 1/16" increments

\* Standard based on seal material

† For PED applications, brass bodies are limited to a maximum temperature of +100° F (+38° C), aluminum bodies are limited to a maximum temperature of +200° F (+93° C)

Note: Vacuum service may require special lubricants.

AND10050 connections not normally recommended for 10000 psi service unless special fitting seals are used.

Please consult Circle Seal Controls or your local distributor for information on special connections, o-rings, operating pressures and temperature ranges.

### Leakage

- 2362, 2332, 2359 Series zero @ 1 psig to proof
- 2333, 2349 Series zero @ 3 psig to proof
- 2320 Series zero @ 75 psig to proof

For cracking pressures less than standard, consult factory for leakage rates

### Special Cracking Pressures

Valves with special springs can be furnished to order

- Minimum cracking pressure available: 0.5 psig
- Maximum cracking pressure available: 30 psig

When ordering a cracking pressure less than the maximum indicated for a specific o-ring, indicate the exact maximum cracking pressure in the part number (i.e. 2349R-2PP-3). If higher cracking pressure than the maximum shown is desired, cracking pressure tolerance is ±20%.

### Flow Rates

Valve size	Tube	-4BB	-6BB	—	-8BB, -10BB	-12BB
	Pipe	-1PP	-2PP	-3PP	-4PP	-6PP
<b>Cv (Maximum)</b>		0.31	0.76	1.78	2.82	5.11

## For Your Safety

It is solely the responsibility of the system designer and user to select products suitable for their specific application requirements and to ensure proper installation, operation, and maintenance of these products. Material compatibility, product ratings and application details should be considered in the selection. Improper selection or use of products described herein can cause personal injury or property damage.

Viton® is a registered trademark of DuPont Dow Elastomers.

# C200 Series

0 to 5000 psig Cartridge Check Valve



## Features

- Large flow capacity
- Compact design
- Floating o-ring

## Benefits

- Maintenance free flow
- Easy installation
- Zero leak
- Quiet closing
- Automatic compensation for wear

## Technical Data

<b>Body Construction Materials</b>	Aluminum, 303 or 316 stainless steel, steel
<b>Finish Materials</b>	Aluminum-anodized, steel black oxide
<b>O-ring Materials</b>	Buna N, PTFE and Viton®
<b>Spring Material</b>	302 stainless steel
<b>Operating Pressure</b>	0 to 5000 psig (345 bar)
<b>Proof Pressure</b>	0 to 7500 psig (517 bar)
<b>Rated Burst Pressure</b>	Over 15000 psig (1,034 bar)
<b>Temperature Range</b>	-100° F to +400° F (-73° C to +204° C) <i>Based on o-ring &amp; body material, see "How to Order"</i>

*Note: Proper filtration is recommended to prevent damage to sealing surfaces.*

## How it Works

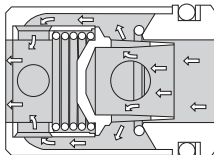

### Open

Full flow passages offer minimum restriction to flow. Spring is completely removed from flow path.

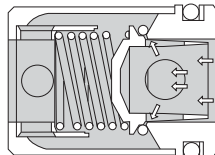

### Closing

Floating o-ring automatically establishes line contact with conical metal surfaces of poppet and seat to cushion closing and insure perfect sealing.

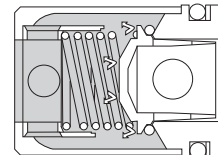

### Closed

O-ring only seals. Full pressure load is carried by metal-to-metal seat. Increasing pressure increases sealing efficiency—metal seat prevents any possibility of deformation or extrusion of o-ring.

check valves

## Circle Seal Controls

2301 Wardlow Circle • Corona, CA 92880  
Phone (951) 270-6200 • Fax (951) 270-6201  
www.circlesealcontrols.com



# C200 Series

## Specifications, Dimensions, Weights & Typical Flow Rates

Model Number	A	B	C	D	E	G	H	J	L* (O-ring) AS568	M* (Backup ring) MS28774	Weight (lbs)	
											Aluminum	St. Steel
-1Q	1.13	0.746	0.34	0.34	0.748	0.245	0.170	0.750	-113	-113	0.05	0.14
-2Q	1.38	0.996	0.43	0.45	0.998	0.298	0.208	1.000	-210	-210	0.09	0.26
-4Q	1.90	1.432	0.72	0.73	1.435	0.306	0.208	1.437	-217	-217	0.24	0.69
-6Q	2.16	1.621	0.92	0.91	1.623	0.380	0.208	1.625	-220	-220	0.37	1.06

\* Valves are furnished complete with o-ring and backup ring.

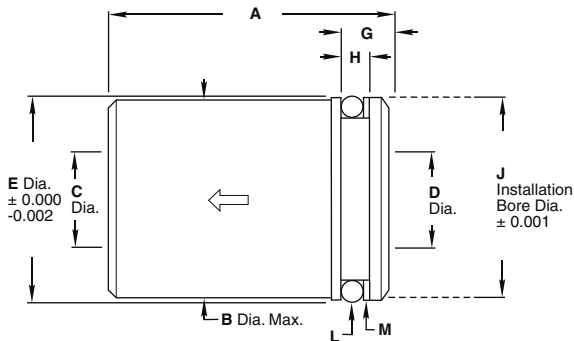

### Flow Rates\*\*

Valve size	-1Q	-2Q	-4Q	-6Q
Cv (nominal)	1.6	2.7	6.6	10.3

\*\* For typical flow rates, see the 200/H200 Series catalog sheet.  
(-1Q = -1PP, -2Q = -2PP, -4Q = -4PP, -6Q = -6PP)

## How to Order

**C2 20 S - 1Q - 5**

### O-RING MATERIAL, TEMPERATURE & CRACKING PRESSURE RANGES

- 49** Buna N, -65° F to +250° F, 2.0-4.0 psig
- 59** Buna N, -65° F to +275° F, 0.5-1.0 psig
- 20** PTFE, -100° F to +400° F, 8 psig maximum
- 32** Viton®, -20° F to +400° F, 0.5-1.0 psig

### BODY MATERIAL

- A** 2024-T4/T351 aluminum<sup>††</sup>
- A1** 6061-T6/T651 aluminum<sup>††</sup>
- S** Steel<sup>†</sup>
- T** 303 stainless steel
- T1** 316 stainless steel

### CRACKING PRESSURE

Call out dash number if not standard  
**5** 5 psig

### CONNECTION SIZE

- 1Q**
- 2Q**
- 4Q**
- 6Q**

<sup>†</sup> Not available for PED applications

<sup>††</sup> For PED applications, aluminum bodies are limited to a maximum temperature of +200° F (+93° C)

Note: Vacuum service may require special lubricants.

Please consult Circle Seal Controls or your local distributor for information on operating pressures, temperature ranges and reseal pressures.

### Leakage

External: Zero

Internal:

Elastomeric seals: Zero

PTFE seals: 0-50 psig = 5cc/min max.  
50+ psig = 0.5cc/min max.

### Cracking Pressure

Minimum cracking pressure available: 0.1 psig

Maximum cracking pressure available: 25 psig

Note: Cracking pressure is defined as pressure at which flow is 5cc/min, except for C220 Series, for which flow is approximately 0.02 cfm. When ordering a cracking pressure within the standard range or below the standard range of cracking pressure, the dash number is a "maximum". Example: C259-1Q-.3 (cracking pressure tolerance will be +0%, -50%). When ordering a cracking pressure equal to or greater than the upper limit of the standard cracking pressure shown above, cracking pressure tolerance will be ±10%. Example: C259S-1Q-5. Cracking pressure over 8 psig should not be specified without consulting the factory. Where C200 Series valves are supplied with higher cracking pressures, a shroud ring may be used to confine the o-ring.

For cracking pressures less than standard, consult factory for leakage rates.

## For Your Safety

It is solely the responsibility of the system designer and user to select products suitable for their specific application requirements and to ensure proper installation, operation, and maintenance of these products. Material compatibility, product ratings and application details should be considered in the selection. Improper selection or use of products described herein can cause personal injury or property damage.

Viton® is a registered trademark of DuPont Dow Elastomers.

## C2900 Series

0 to 3000 psig Cartridge Check Valve



### Features

- Compact & easily installed
- Curved poppet face
- Zero leakage—"bubble-tight" in check direction

### Benefits

- Quick opening, positive closing
- Full flow—curved poppet face diverts flow smoothly with minimum pressure drop
- In addition to being used in new equipment, they are interchangeable with and can be used to replace many cartridge valves

### Technical Data

<b>Body Construction Materials</b>	Brass, carbon steel, 303 or 316 stainless steel
<b>O-ring Materials</b>	Buna N, ethylene propylene and Viton®
<b>Operating Pressure</b>	0 to 3000 psig (207 bar)
<b>Cracking Pressure</b>	0.15 to 15 psig (0.01 to 1 bar)
<b>Temperature Range</b>	-65° F to +300° F (-54° C to +149° C) <i>Based on o-ring &amp; body material, see "How to Order"</i>

*Note: Proper filtration is recommended to prevent damage to sealing surfaces.*

### How it Works

The proven sealing principle of Circle Seal Check Valves is employed in the C2900 Series cartridge-type valves—instant, bubble-tight sealing with an o-ring. Increasing pressure makes the seal tighter until metal-to-metal contact is made, which withstands full system pressures or pressure surges.

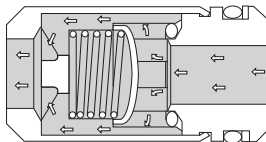

#### Open

In the flow position, the convex curved surface of the spring-loaded poppet permits full flow. The required cracking pressure is governed by the spring.

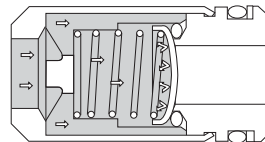

#### Closed

Closing to check position at the slightest back pressure, the dynamic o-ring seals instantly between the poppet and seat.

check valves

### Circle Seal Controls

2301 Wardlow Circle • Corona, CA 92880  
Phone (951) 270-6200 • Fax (951) 270-6201  
www.circlesealcontrols.com

# C2900 Series

## Specifications, Dimensions, Weights & Typical Flow Curves

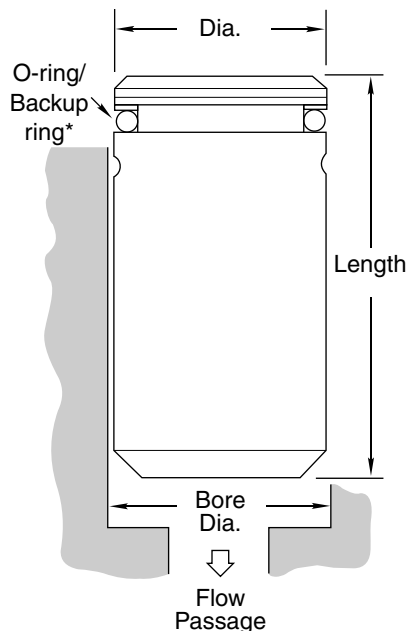

Model Number	Bore Dia. +0.002, -0.000	Flow Passage	Dia. +0.005, -0.000	Length	O-ring* AS568	Backup Ring* MS28774	Cv
-4Q	0.501	0.200	0.494	0.830	-012	-012	0.55
-6Q	0.657	0.300	0.650	1.215	-014	-014	1.36
-8Q	0.813	0.385	0.806	1.490	-017	-017	2.35
-10Q	1.001	0.485	0.994	1.545	-020	-020	3.51
-12Q	1.219	0.850	1.212	1.930	-023	-023	5.66

\* Valves are furnished complete with o-ring and backup ring.

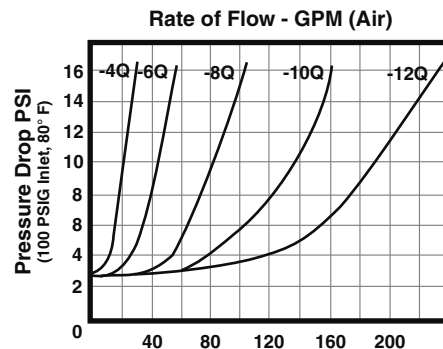
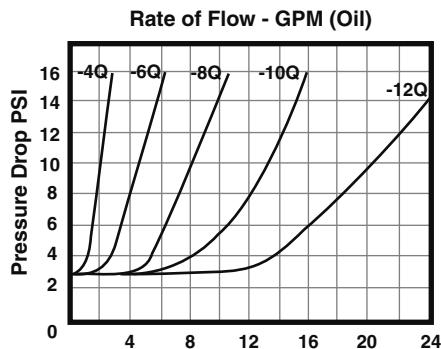

## How to Order

**C29 49 S - 8Q - 15**

### O-RING MATERIAL & TEMPERATURE RANGES

- 49** Buna N, -65° F to +250° F
- 52** Viton®, -20° F to +300° F
- 62** EPR, -65° F to +300° F

### BODY MATERIAL

- B** Brass
- S** Steel†
- T** 303 stainless steel
- T1** 316 stainless steel

### CRACKING PRESSURE

Call out dash number if not standard (2-4 psig is standard)  
**15** 15 psig

### CONNECTION SIZE

- 4Q**
- 6Q**
- 8Q**
- 10Q**
- 12Q**

† Not available for PED applications.

Please consult Circle Seal Controls or your local distributor for information on special connections, o-rings, operating pressures, reseal pressures and temperature ranges.

**Leakage (internal):** Zero from 0 to 3000 psig

### Cracking Pressure

Minimum cracking pressure available: 0.15 psig

Maximum cracking pressure available: 15 psig

Note: Cracking pressure is defined as pressure at which flow is 5cc/min. When ordering a cracking pressure within the standard range and below, the dash number is a "maximum". For cracking pressure equal to or greater than the upper limit, the tolerance will be ±20%.

## For Your Safety

It is solely the responsibility of the system designer and user to select products suitable for their specific application requirements and to ensure proper installation, operation, and maintenance of these products. Material compatibility, product ratings and application details should be considered in the selection. Improper selection or use of products described herein can cause personal injury or property damage.

Viton® is a registered trademark of DuPont Dow Elastomers.

**400 Series** 0 to 3000 psig Shuttle Valves

**H400 Series** 0 to 6000 psig Shuttle Valves

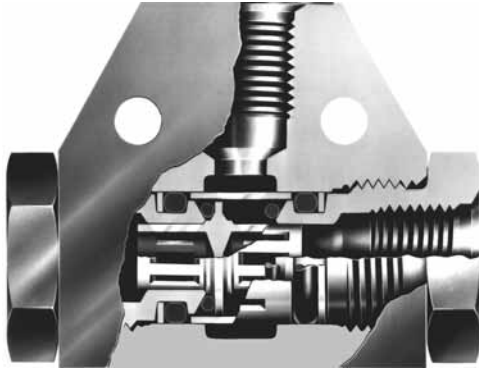

### Features & Benefits

#### Quick, positive operation

- Minimum interflow
- No breakaway friction

#### Double poppet

- The shuttle actuates immediately on overriding pressure

#### Positive sealing

- Zero leak

### Technical Data

<b>Body Construction Materials</b>	Aluminum, brass or 303 stainless steel
<b>O-ring Materials</b>	Buna N, neoprene and Viton®
<b>Operating Pressure</b>	<ul style="list-style-type: none"> <li>• 400 Series: 0 to 3000 psig (207 bar)</li> <li>• H400 Series: 0 to 6000 psig (414 bar)</li> </ul>
<b>Proof Pressure</b>	<ul style="list-style-type: none"> <li>• 400 Series: 4500 psig (310 bar)</li> <li>• H400 Series: 9000 psig (621 bar)</li> </ul>
<b>Rated Burst Pressure</b>	<ul style="list-style-type: none"> <li>• 400 Series: 7500 psig (517 bar) minimum</li> <li>• H400 Series: over 15000 psig (1,034 bar)</li> </ul>
<b>Temperature Range</b>	-320° F to +400° F (-196° C to +204° C) <i>Based on o-ring &amp; body material, see "How to Order"</i>
<b>Connection Sizes</b>	1/8" to 1/2"

*Note: Proper filtration is recommended to prevent damage to sealing surfaces.*

### How it Works

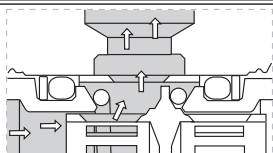

#### One Inlet to Common Outlet

The flow passes easily through the shuttle ports to the common outlet. The o-ring is completely contained by the inner sleeve.

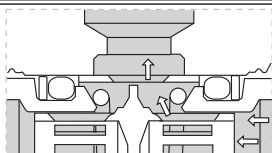

#### Shuttling

The shuttle actuates immediately on overriding pressure from the alternate inlet with no breakaway friction and minimum interflow.

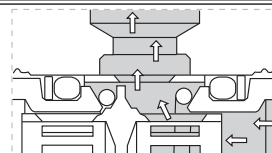

#### Alternate Inlet to Common Outlet

The flow passes from the alternate port to the common outlet. The floating o-ring seals block the port and prevent leakage with pressure differential of less than 1 psig to 3000 psig.

check valves

### Circle Seal Controls

2301 Wardlow Circle • Corona, CA 92880  
 Phone (951) 270-6200 Fax (951) 270-6201  
 www.circlesealcontrols.com

# 400 Series/H400 Series

## Leakage

Body leakage:	Zero
Internal leakage:	
459, 432 Series:	Zero @ 2 psig up to proof
433, 449 Series:	Zero @ 5 psig up to proof
420T Series:	Zero @ 100 psig up to proof
	10cc/min max. @ 10 to 100 psig
	20cc/min max. @ 1 to 10 psig
420A Series:	1cc/min @ 100 psig up

Zero leakage is  $3 \times 10^{-4}$  cc/min

## Flow Rates

Valve size	Tube	-4BB	-6BB	-8BB
	Pipe	—	-1PP	-2PP
<b>Cv (maximum)</b>		0.46	1.34	2.26

## Dimensions (Inches)

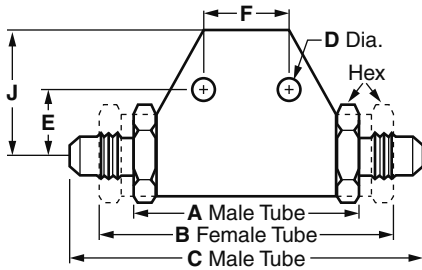

### Female Tube / Male Tube

Dash No.	Size	A ±0.050	B ±0.050	C Ref.	D ±0.050	E 0.015	F ±0.005	G/J	H	K
-4BBB / -4TTB	¼"	2.02	2.02	3.12	0.193	0.56	0.875	1.00	0.75	1.50
-6BBB / -6TTB	⅜"	2.02	2.94	3.13	0.193	0.56	0.875	1.00	0.81	1.50
-8BBB / -8TTB	½"	2.38	3.53	3.70	0.193	0.81	1.125	1.25	1.00	1.87

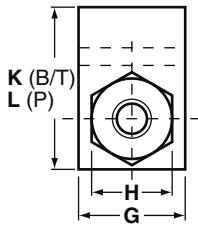

### Female Pipe

Dash No.	Size	A ±0.050	B ±0.015	C ±0.005	D ±0.050	G	H	J	L
-1PPP	⅜"	2.02	0.53	0.875	0.193	1.00	0.81	0.75	1.25
-2PPP	¼"	2.39	0.66	1.125	0.193	1.25	1.00	0.91	1.50
-3PPP	⅜"	2.66	0.79	1.375	0.193	1.25	1.12	1.10	1.75
-4PPP	½"	3.20	1.02	1.625	0.193	1.75	1.50	1.37	2.25

# 400 Series/H400 Series

## How to Order

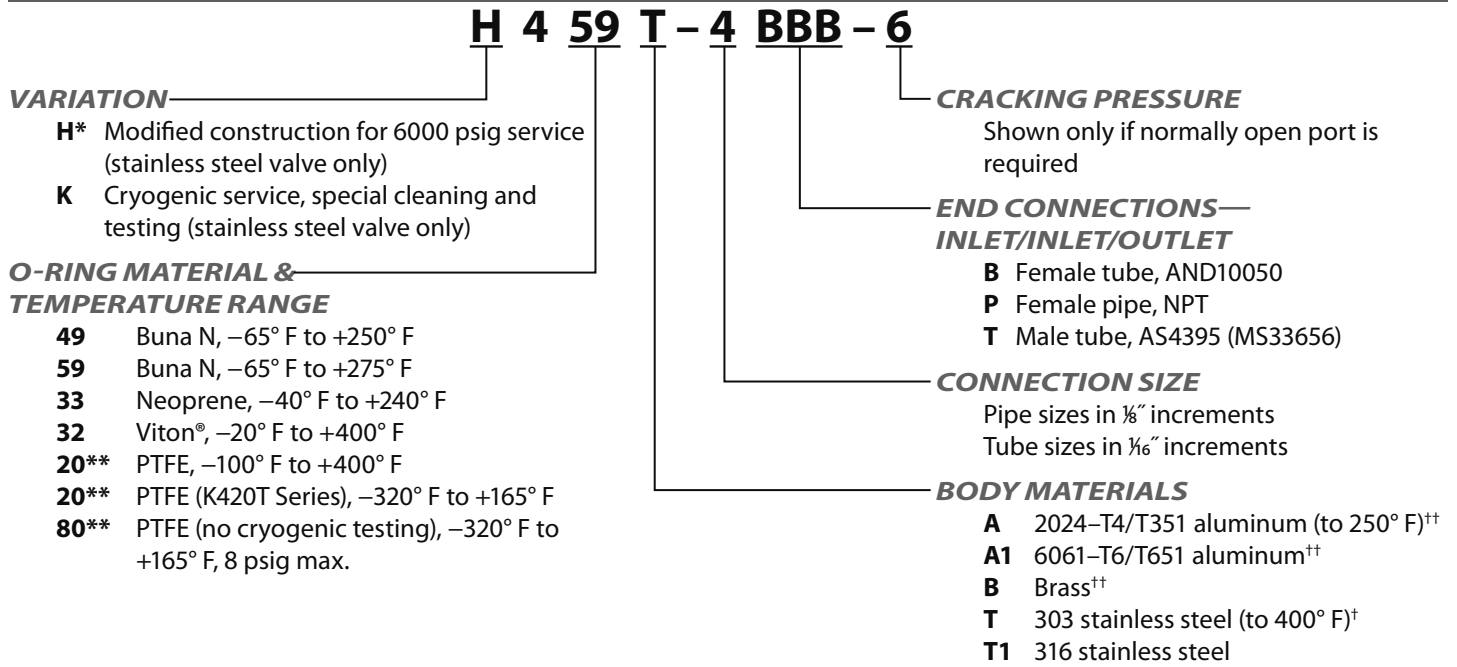

\* Up to and including 1/2" tube and 1/4" pipe.

\*\* For PTFE, specify stainless steel body material. The stainless steel valve design provides a PTFE static seal for use in systems with low or high temperatures or with liquids or gases which would cause excessive swell or shrinkage of elastomeric compounds.

† Not available for PED applications.

†† For PED applications, brass bodies are limited to a maximum temperature of +100° F (+38° C), aluminum bodies are limited to a maximum temperature of +200° F (+93° C).

Please consult Circle Seal Controls or your local distributor for information on special connections, materials, larger sizes, o-rings, operating pressures and temperature ranges.

### Notes:

The common port is female tube or female pipe. Inlet ports may be female or male tube, or a combination of the two, or female pipe.

The 400 Series Shuttle Valves are manufactured with three-piece bodies, which are sealed with two synthetic o-rings or PTFE gaskets to prevent external leakage.

Where a normally open port is required, the shuttle is spring-loaded (except with female pipe and tube connections). The cracking pressure is the nominal pressure (tolerance ±15%) against which the shuttle will start to move to allow flow from the normally open port. Shuttling pressure, to close normally open port, is 2 to 5 times this pressure.

### Repair Kits

In normal service, the only part(s) which may require replacement is(are) the seals. A repair kit may be ordered by placing a 'K/' in front of the complete part number (i.e. K/H459T-4BBB-6).

## For Your Safety

It is solely the responsibility of the system designer and user to select products suitable for their specific application requirements and to ensure proper installation, operation, and maintenance of these products. Material compatibility, product ratings and application details should be considered in the selection. Improper selection or use of products described herein can cause personal injury or property damage.

Viton® is a registered trademark of DuPont Dow Elastomers.



## BIVCO Check Valves



BIVCO valves are considered all-purpose valves because they can be tailored in the right combination of materials for the job at hand...for liquids, including acids, alkalis, formaldehyde, solvents, oils, gasoline, water, sea water, deionized water, pharmaceutical liquids, steam condensates, refrigerants...for gases including air, oxygen, argon, helium, nitrogen, dry chlorine, sulphur dioxide...for vapors including saturated steam, wet chlorine, and various others.

### Operating Characteristics

- **Versatility** BIVCO valves may be used in either liquid or gas systems.
- **No Leakage** Bubble-tight sealing is provided even at very low-pressure differentials.
- **Fast Response** The poppet design, which is light in weight and functions as "sail", is acted upon by fluid in the system to cause rapid and full opening of the valve regardless of installed position.
- **Dependability** The use of PTFE or other high performance plastic materials provides resiliency to shock and long life under various conditions.
- **Low Pressure Drop** Large passageways provide flow characteristics with lower pressure drop than competing valves.
- **Non-sticking** The free-floating seat and poppet design prevents sticking due to canting of the disk member. PTFE used in seats and poppets is self-lubricating and resistant to corrosion.
- **Noise Free** Chatter due to pulsation in the fluid system is absorbed by the resilient materials and unique design of the seat and poppet.
- **Adaptable to Most Fluids** Standard bronze, brass, steel, and stainless steel valves with PTFE seats and poppets are suitable for a wide range of fluids. Valves with bodies of PTFE are BIVCO specialties for corrosive fluids.

### How it Works

#### The BIVCO Floating Seat and Poppet

The operating principles of BIVCO valves are unique. The conical seat of PTFE or other high performance plastic fits loosely when snapped in place and then becomes free floating, permitting horizontal, vertical and radial movement. In the closed position, the wedge-like action of the conical poppet seals the seat against the body, assuring positive, bubble-tight sealing. In the open position, the seat again becomes free floating.

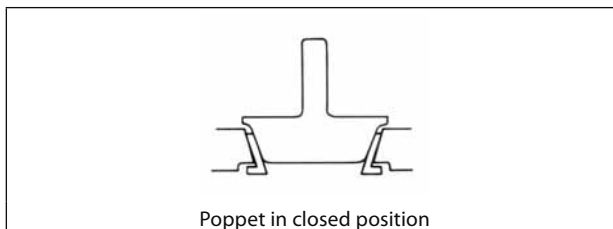
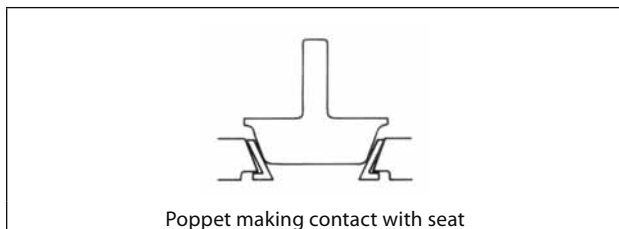

#### Circle Seal Controls

2301 Wardlow Circle • Corona, CA 92880  
 Phone (951) 270-6200 • Fax (951) 270-6201  
[www.circlesealcontrols.com](http://www.circlesealcontrols.com)



# BIVCO Check Valves

## *Lift Type: 1000 Series*

Bodies of Cast Bronze or Stainless Steel

### **Description**

BIVCO 1000 Series are highly reliable lift type models which provide positive, zero leakage sealing and low-pressure drop. The standard model has NPT Female end connections. Other models are available including configurations with socket ends for welding or soldering to pipe, and with flanged ends. All models are normally supplied with light springs for nominal 0.5 psig cracking pressure. Valves may be ordered with no spring or with springs in a range of cracking pressures.

### **Special Features**

Large seating areas provide very sensitive opening pressures and fast response. Seats, poppets and o-rings are easily replaced. Poppet is backstopped by a guide to prevent overstressing spring. Operation is chatter-free.

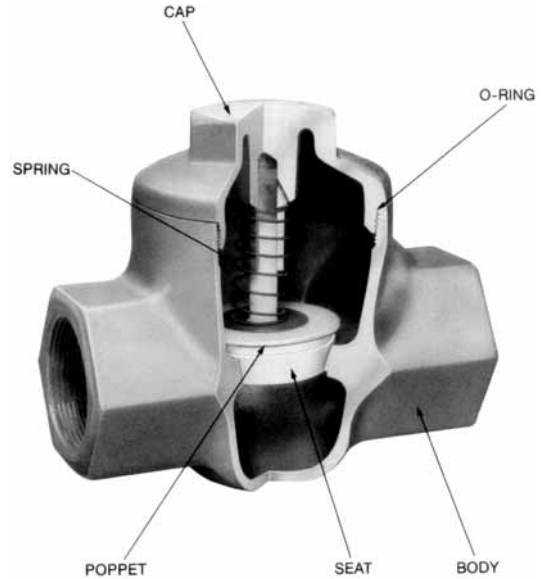

## *In-line Type: 3000 / 4000 Series*

Bodies of Machined Bar Stock

### **Description**

BIVCO 3000 / 4000 Series of check valve models are designed to work with the same floating seats and poppets as the 1000 Series. The standard model has NPT Female end connections. Other models are available, including configurations with socket ends for welding or soldering to pipe, and with flanged ends. All models are normally supplied with light springs for nominal 0.5 psig cracking pressures. Valves may be ordered with no spring or with springs in a range of cracking pressure. Standard body materials are brass, stainless steel, and carbon steel. See "How to Order" chart.

### **Special Features**

Large seating areas provide sensitivity and fast response. In-line models exhibit extremely low-pressure drop and can be truly called full flow valves. Poppet is backstopped by a guide to prevent overstressing the spring. Operation is chatter-free.

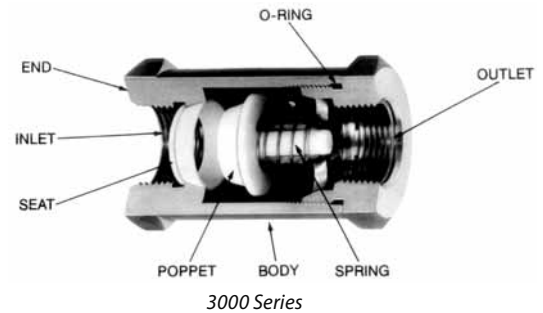

3000 Series

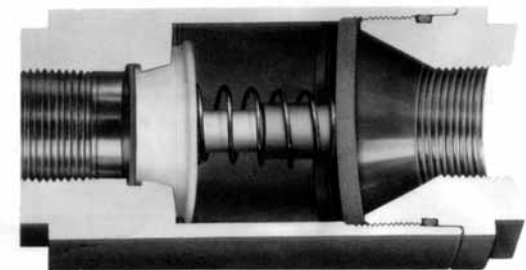

4000 Series

# BIVCO Check Valves

## *BIVCO Valve Applications*

---

Besides check and valve functions, all purpose BIVCO valves are designed for pressurizing, vacuum breaking or holding, positive shutoff, antisiphoning, back flow protection and foot-valve operations. Successful applications of BIVCO valves include the following industrial processes:

Chemical processing  
Metallurgical processing  
Photographic filmmaking  
Nuclear power  
Water purification  
Steam heating systems  
Pharmaceutical processing  
Research laboratories

Gas compression  
Food processing  
Plastics manufacturing  
Naval ships instrumentation  
Oil / water separation  
Paper making  
Chlorine battery development  
Beverage bottling equipment

Plating processed  
Missile systems  
Fuel handling  
Distillation processes  
Refrigerant handling  
Original equipment manufacturing

## *Applications by Valve Type and Series*

---

BIVCO valves are considered all-purpose valves because they can be tailored in the right combination of materials for the job at hand...for liquids, including acids, alkalais, formaldehyde, solvents, oils, gasoline, water, sea water, deionized water, pharmaceutical liquids, steam condensates, refrigerants...for gases including air, oxygen, argon, helium, nitrogen, dry chlorine, sulphur dioxide...for vapors including saturated steam, wet chlorine, and various others.

### **BIVCO Lift Type 1000 Series**

- Check valve in oxygen and air line downstream of control valve
- Check valve for process gas
- Check valves in nitrogen lines, subject to radiation
- Vacuum breakers in vapor system of water desalinization equipment
- Check valves for steam condensate, temperature 180°–200° F
- Air vent and liquid flow control valves in oil-water separation

### **BIVCO In-line Type 3000 / 4000 Series**

- Check valve in hydrofluoric acid feed line.
- Check valve for steam to prevent back flow of caustic materials
- Check valve for use in dry chlorine service
- Check valve for service in formic acid and formaldehyde
- Check valve in chlorine purge rotometer line
- Check valve in packaging equipment for precise metering of pharmaceutical liquids
- Check valve between stages of rotary air compressor
- Check valve in caustic soda and water system for cleaning pipes in milk plant
- Check valve for hot caustic liquor
- Check valve in air line to prevent back flow of carbonated beverage
- Check valves in steam system for return condensation, chlorine present

# BIVCO Check Valves

## Dimensions (inches), Technical Data & Cv Ratings

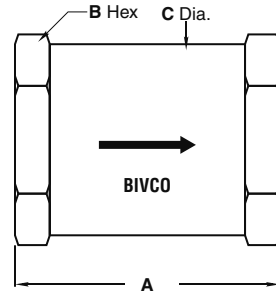
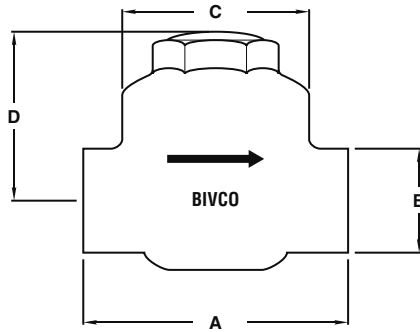

### Model 1000 Series Lift Check: Bronze

Part No.	Size	A Length	B Hex	C Dia.	D	Cv* (Nominal)
1006	3/8	25/16	1	15/8	15/8	2.75
1008	1/2	23/4	1 1/8	115/16	113/16	4.37
1012	3/4	31/2	1 3/8	211/16	257/16	8.40
1016	1	45/8	1 3/4	31/16	213/16	12.76
1020	1 1/4	53/4	2 1/4	39/16	35/8	16.70
1024	1 1/2	61/4	2 1/2	41/16	33/8	21.77
1032	2	71/2	3	49/16	41/2	32.02

### 3000 Series In-line

Part No.	Size	A Length	B Hex	C Dia.	Cv* (Nominal)
3004	1/4	21/4	11/8	11/8	2.96
3006	3/8	27/16	13/8	13/8	6.18
3008	1/2	27/8	1 1/2	1 1/2	10.88
3012	3/4	33/8	2	2	18.25
3016	1	33/4	2 1/4	2 1/4	24.81

### Model 1000 Series Lift Check: CRES 316

Part No.	Size	A Length	B Hex	C Dia.	D	Cv* (Nominal)
1008	1/2	4	1 3/8	23/4	2 3/8	4.37
1012	3/4	4	1 3/8	23/4	2 3/8	8.40
1016	1	45/8	1 3/4	31/16	213/16	12.76
1020	1 1/4	53/4	2 1/4	39/16	35/8	16.70
1024	1 1/2	61/4	2 1/2	41/16	33/8	21.77
1032	2	71/2	3	49/16	49/16	32.02

### 4000 Series In-line

Part No.	Size	A Length	B Hex	C Dia.	Cv* (Nominal)
4020	1 1/4	6	3	3 1/2	35.00
4024	1 1/2	6	3	3 1/2	36.50
4032	2	69/16	3 1/2	4	51.15
4048	3	103/16	5 1/4	6 1/2	70.05

\* Flow coefficient (Cv) with standard 0.5 psig spring

### Operating Pressure Range 1000, 3000, And 4000 Series @ 70° F

(See Temperature Derating Table)

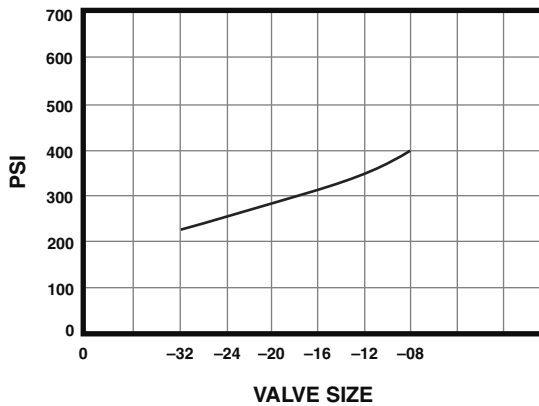

Note: Pressure in reverse direction limited to 120 psig.

### Temperature derating factor 'K' for maximum allowable reverse pressure at given ambient and/or media temperature

°F	73	150	212	250
'K' PTFE	1.0	0.65	0.47	0.34

# BIVCO Check Valves

## How to Order: 1000 Series

**10 08 B 0 0 V - 0.5 S**

**MODEL**

- 10** NPT female
- 13** Socket weld end for pipe<sup>1,3</sup> (stainless valve only)
- 14** Socket for soldering to pipe<sup>1,3</sup>
- 15** Raised face flange 150lb ANSI, B16.5<sup>2,3</sup>  
Consult factory for models with other end connections.

**SIZE**

- 06** 3/8"
- 08** 1/2"
- 12** 3/4"
- 20** 1 1/4"
- 24** 1 1/2"
- 32** 2"

**MATERIAL OF BODY**

- B** Bronze, B-62 cast
- S** Stainless steel, 316 cast

**SPRING MATERIAL**

- S** 316 stainless steel

**CRACKING PRESSURE**

Lbs/in<sup>2</sup> rating (always 3 spaces)  
(Example: 0.5 = 1/2 psig, 010 = 10 psig).  
See cracking pressure options, this page, for available ranges.

**MATERIAL OF O-RING IN BODY**

- T** PTFE
- V** Viton®

**MATERIAL OF POPPET**

- 0** PTFE

**MATERIAL OF SEAT**

- 0** PTFE

**Notes**

- <sup>1</sup> Dimensions of socket ends are available on request.
- <sup>2</sup> Model with raised face 150lbs. Flange is available to special order in sizes 3/4" through 2" in bronze or stainless steel. Dimensions supplied on request.
- <sup>3</sup> A minimum order of 10 pieces is required.

**Repair Kit**

In normal service the only parts which may require replacement are the seat, poppet and o-ring. A complete repair kit may be ordered, specify kit followed by the complete valve part number.

**PSIG Cracking Pressure Options/Ranges for 1000 Series**

Part No.	Nominal	_0.5	_002	_004	_006	_008	_010
1000 Series	Maximum	1.0	2.6	5.2	7.7	10.3	13.0
	Minimum	0.2	1.6	3.2	4.8	6.4	7.8

**Leakage**

1 cc/min at 0-5 psig  
Zero at 5 psig to proof

# BIVCO Check Valves

## How to Order: 3000 & 4000 Series

**30 12 C 0 0 T - 008 C**

**MODEL**

- 30** NPT female (sizes ¼" to 1")
- 33** Socket weld end for pipe<sup>1,3</sup> (sizes ¼" to 1")
- 40** NPT female (sizes 1¼" to 3")
- 43** Socket weld end for pipe<sup>1,3</sup>
- 45** Raised face flange 150lbs ANSI B16.5<sup>2,3</sup>  
Consult factory for models with other end connections.

**SIZE**

Pipe size in ⅙"

(also used for tubing size in ⅙" when applicable for special ends)

**MATERIAL OF BODY**

- B** Brass, 360
- C** Steel, 1018/1020<sup>†</sup>
- S** 316 stainless steel

**SPRING MATERIAL**

- S** 316 stainless steel
- C** 316 stainless steel, coated

**CRACKING PRESSURE**

Lbs/in<sup>2</sup> rating (always 3 spaces)  
(Example: 0.5 = ½ psig, 010 = 10 psig).  
See cracking pressure options, this page, for available ranges.

**MATERIAL OF O-RING IN BODY**

- T** PTFE
- V** Viton®

**MATERIAL OF POPPET**

- 0** PTFE
- 1** Reinforced TFE

**MATERIAL OF SEAT**

- 0** PTFE

**Notes**

- <sup>1</sup> Dimensions of socket ends are available on request.
- <sup>2</sup> Model with raised face flange is available to special order. Flange is slip-on type welded to nipple in socket weld end of valve. Dimensions supplied on request.
- <sup>3</sup> A minimum order of 10 pieces is required. 1" and above
- <sup>4</sup> For 4048 Series, consult the factor.
- <sup>†</sup> For 3000 Series, not available for PED applications.

### Repair Kit

In normal service the only parts which may require replacement are the seat, poppet and o-ring. A complete repair kit may be ordered, specify kit followed by the complete valve part number.

### PSIG Cracking Pressure Options/Ranges for 3000 & 4000 Series

Part No.	Nominal	_0.5	_002	_004	_006	_008	_010
<b>3000 Series</b>	<b>Maximum</b>	1.0	2.7	5.3	7.9	10.5	13.2
<b>4000 Series</b>	<b>Minimum</b>	0.2	1.6	3.1	4.8	6.4	8.0

### Leakage

1 cc/min at 0–5 psig  
Zero at 5 psig to proof

### For Your Safety

It is solely the responsibility of the system designer and user to select products suitable for their specific application requirements and to ensure proper installation, operation, and maintenance of these products. Material compatibility, product ratings and application details should be considered in the selection. Improper selection or use of products described herein can cause personal injury or property damage.

# Check Valve Specification Check Sheet

## Customer Information

Customer Name	
Company Name	
Address	
Telephone	Fax
E-mail	

## Application Information

Application	
Maximum Operating Pressure	PSIG / BAR (circle one)
Operating Temperature Max:	°F / °C (circle one) Min: °F / °C (circle one)
System Fluid(s)	
Cracking Pressure (Set)	psig / BAR (circle one)
<i>Note: Standard cracking pressure is defined as a flow of 5cc/min for elastomers, 0.02 scfm (600cc) for PTFE</i>	
Allowable Leakage	
Flow Rate (Min)	SCFM / GPM at Maximum Pressure Drop

## Valve Information

### Materials

Body	Trim	Seal
------	------	------

### Line Connections

Inlet Size	Type
Outlet Size	Type

### Envelope Requirements

L	W	H
Maximum Weight		
Units Must Meet the Following Specifications		
Number of Units Required:	Now	Yearly
Target Price		

# Check Valve Specification Check Sheet

## Customer Information

Customer Name

Company Name

Address

Telephone

Fax

E-mail

## Application Information

Application

Maximum Operating Pressure

PSIG / BAR (circle one)

Operating Temperature Max:

°F / °C (circle one)

Min:

°F / °C (circle one)

System Fluid(s)

Cracking Pressure (Set)

psig / BAR (circle one)

*Note: Standard cracking pressure is defined as a flow of 5cc/min for elastomers, 0.02 scfm (600cc) for PTFE*

Allowable Leakage

Flow Rate (Min)

SCFM / GPM at Maximum Pressure Drop

## Valve Information

### Materials

Body

Trim

Seal

### Line Connections

Inlet Size

Type

Outlet Size

Type

### Envelope Requirements

L

W

H

Maximum Weight

Units Must Meet the Following Specifications

Number of Units Required:

Now

Yearly

Target Price







# **CIRCOR**

INSTRUMENTATION TECHNOLOGIES



**CIRCOR Instrumentation Technologies (CIT) is the logical choice for fluid control solutions. We provide the lowest cost of ownership, offering the best in class reliability and availability of our products. We have global coverage, delivering value in the form of local, flexible service to meet our customer's needs. CIT is a product group specializing in instrumentation with orifice sizes typically up to 2".**

**Our corporate head office and ISO 9001:2000 registered  
manufacturing facilities are located at  
405 Centura Court  
Spartanburg, SC, USA, 29303  
Tel +1-864-574-7966  
Fax +1-864-587-5608  
[www.hoke.com](http://www.hoke.com)  
[www.circortechnologies.com](http://www.circortechnologies.com)**

**Proudly Distributed By:**

